

# Pressure sensors “ Miniature“

with internal and front flush diaphragm

accuracy 0.5 %

standard output: 4 ... 20 mA; 2-wire-system  
 or 0.1...10 VDC; 3-wire system  
 or 1 ... 5 VDC; 3-wire system



## Description

Pressure sensors „Miniature“ are top of the range pressure transducers.

Due to its miniaturized construction they are the perfect choice for extreme space-saving installation. Reliability, resistance to corrosion and mechanical load make them suitable for all pressure measuring tasks.

The measuring ranges, graded in accordance with EN, range from 16 bar to the maximum pressure range of 1000 bar. The case and wetted parts comprise stainless steel and are thus resistant to chemically aggressive media. The pressure connection and measuring element are welded together, making the measuring system particularly resistant to mechanical shock or vibration.

Round connectors M12x1, DIN 43650 C plugs or cable outlets are used to pick up the electrical output signals.

The pressure sensors „Miniature“ meet the electronic magnetic compatibility (EMC) requirements to EN 61326.

## Features

- o miniaturized construction
- o pressure connection G ¼ B to DIN 3852 E or G1/4 B front flush
- o high peak pressure resistance
- o high alternating load resistance
- o high long-term stability
- o corrosion resistant stainless steel design
- o resistant to mechanical load
- o for dynamic and static measurements

## Measuring ranges

Gauge pressure

positive	0...16 bar to 0...1000 bar with internal diaphragm
positive	0...25 bar up to 0...1000 bar with front flush diaphragm

## Applications

Hydraulics and pneumatics,  
 general mechanical engineering,  
 medical engineering

Models: P3325, P3326

## Technical data

Model	P3325	P3326	Option
Pressure type	positive gauge pressure		positive gauge pressure
Output signal	4...20 mA - 2- wire system 1...5 V - 3- wire system 0.1...10 VDC - 3- wire system		
Accuracy	0.5 % of F.S. 1)		
Ranges to EN	0...16 bar to 0...1000 bar	0...25 bar to 0...600 bar	other on request
Sensor element	thin film		
Repeatability	≤ ± 0.05 % of F.S.		
Stability per year	≤ ± 0.2 % of F.S. in rated conditions		
Case	stainless steel 1.4571		
Pressure connection	G ¼ A to DIN 3852 form E with Viton <sup>®</sup> 4), sealing G ¼ B to EN 837	G ¼ B front flush diaphragm with o-ring	other on request
Wetted parts	stainless steel 1.4571 and 1.4542	stainless steel 1.4571, NBR	
Overload limit	≤ 600 bar 2- x = 1000 bar 1.5- x vacuum resistant		
Electrical connection	round connector M12x1 (4-pin) cable outlet with 1.5 m cable plug DIN 43650 C with junction box		
Power supply	10 ... 30 VDC 8 ... 30 VDC 14 ... 30 VDC		
Power consumption	current output: signal current voltage output: 8 mA		
Load	RA [Ω] ≤ (UB [V] - 10 V) / 0.02 A > 10 kΩ > 20 kΩ		
Temperature comp. range	-20 ... 85°C		
Temperature influence	± 0.2 % / 10 K, on zero and span		
Response time	≤ 2 ms (within 10 % to 90 % of F.S.)		
Protection type	IP65 to EN 60 529/IEC 529		IP67 on request
Emission 2)	to EN 61326		
Interference 2)	to EN 61326		
Electrical protection types	polarity, overload and short-circuit protection		
Temperature ranges	-40 ... 100 °C -40 ... 100 °C -40 ... 100 °C		
Weight	ca. 0.05 kg		

of F.S. = of full scale value

- 1) Terminal point adjustment according to DIN 16 086, incl. linearity and hysteresis
- 2) Declaration of conformity on request
- 3) Version for oxygen from 25 bar, max. 60°C
- 4) Viton<sup>®</sup> fluoroelastomer, a product of DuPont Dow Elastomers

# Dimensions

## Case

round connector M12x1

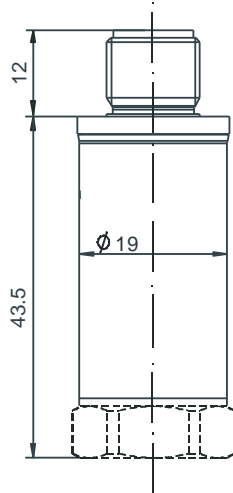

plug DIN 43650 C

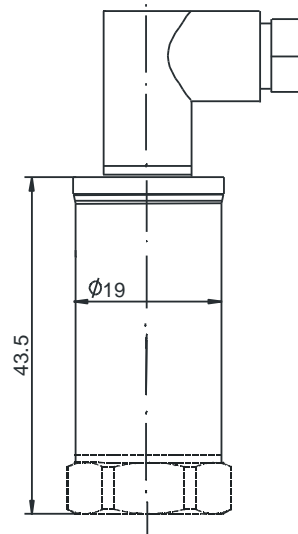

cable outlet

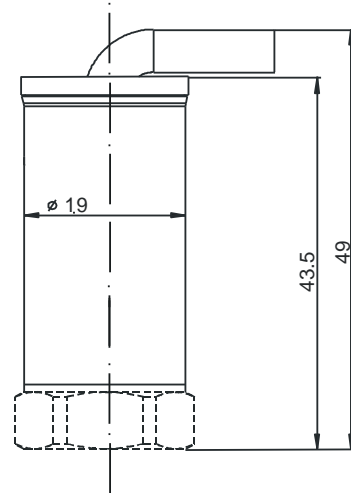

## Pressure connection

internal diaphragm

G 1/4 A DIN 3852 -E

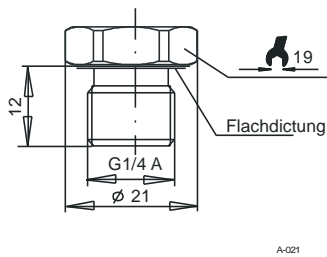

G 1/4 B EN 837

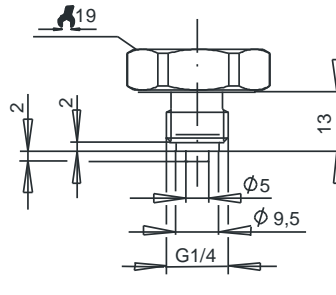

front flush diaphragm

G 1/4 B

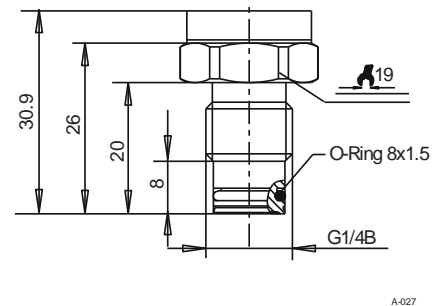

## Screw-in aperture to

G 1/4 DIN 3852-E

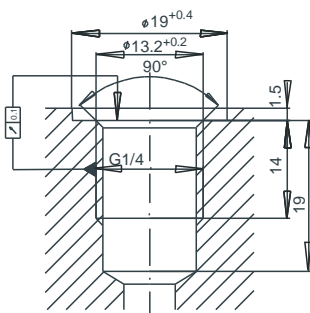

G 1/4

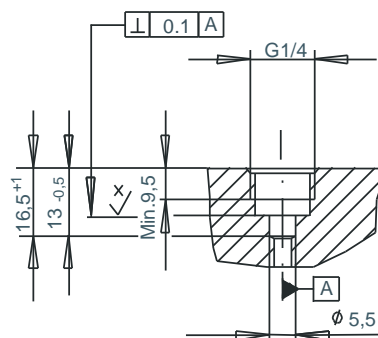

G 1/4

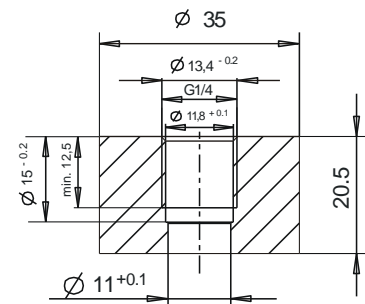

S-009

# Electrical connection

## Two-wire system

round connector M12x1

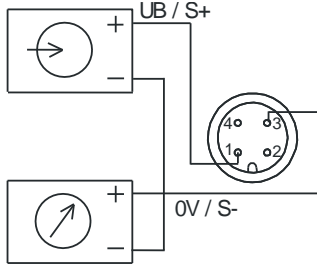

E-033

plug DIN 43650 C

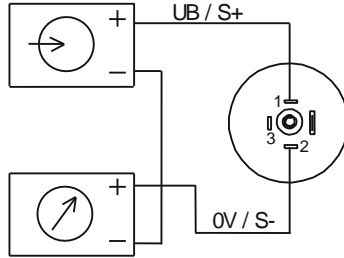

E-005

cable outlet

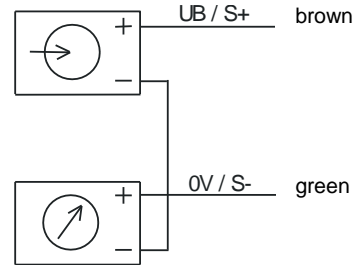

E-015

## Three-wire system

round connector M12x1

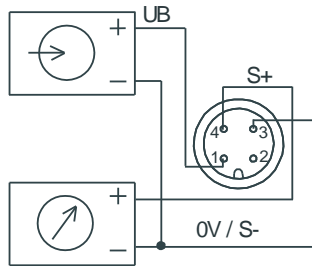

E-034

plug DIN 43650 C

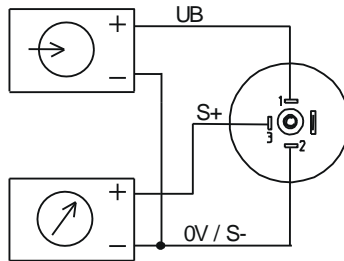

E-006

cable outlet

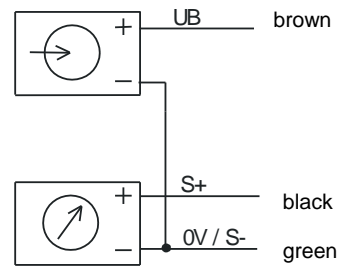

E-017

## Connection table for DIN plug or cable outlet

	4...20 mA (2 - wire)			0...10VDC (3 - wire)		
	plug M12x1	DIN plug	cable outlet	plug M12x1	DIN plug	cable outlet
Supply: UB+	1	1	brown	1	1	brown
Supply: 0V	3	2	green	3	2	green
Signal: S+		-	-	4	3	white
Signal: S-		-	-	3	2	green

## Order details

1. Model
2. Measuring range
3. Output signal
4. Options

Modifications reserved